

Installation Instructions

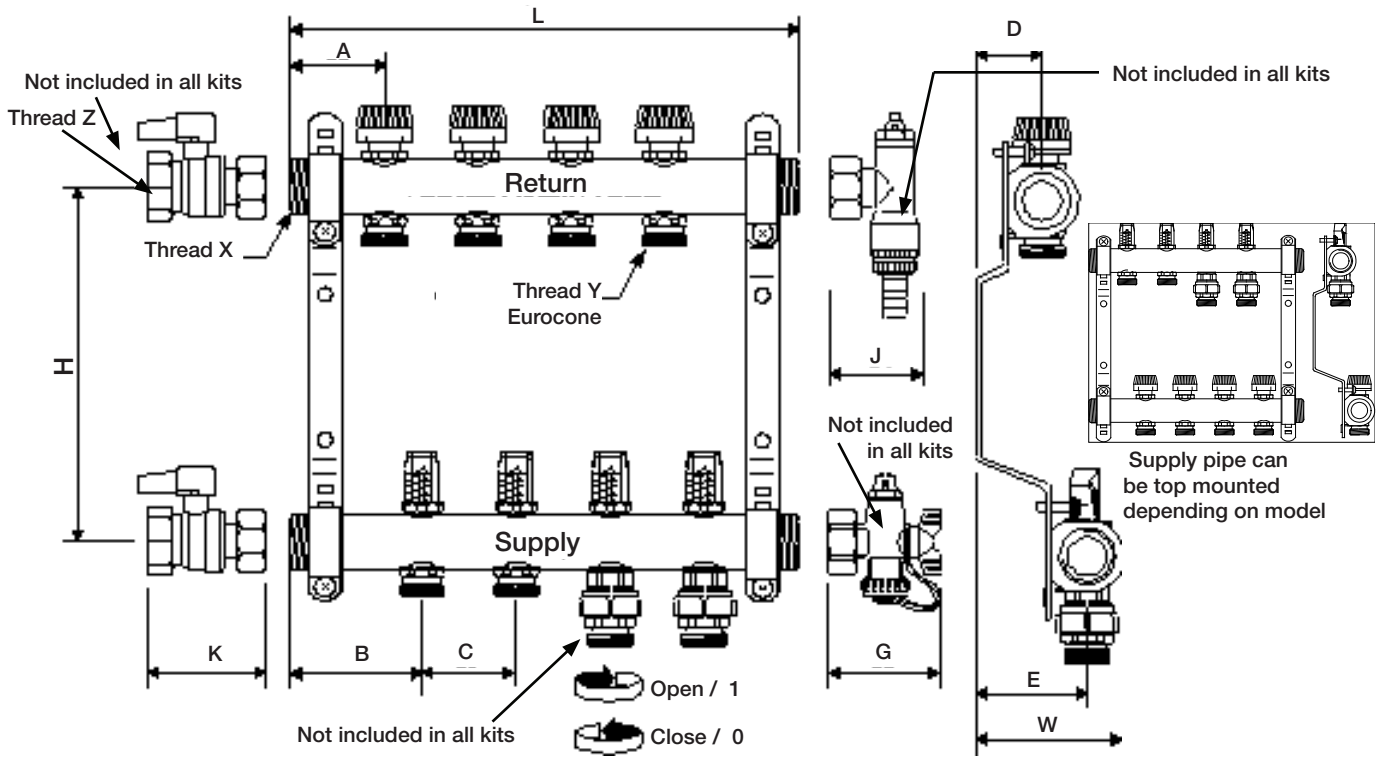

Manifold Model Dimensions	Manifold										Threads		
	H	A	B	C	D	E	W	G	J	K	X	Y	Z
ProMix 2013 1" Stainless Steel	~8 1/4"	2 3/16"	~3 1/8"	2 3/16"	~1 1/2"	~2 1/2"	~3 3/8"	2 1/2"	~1 3/8"	2 1/2"	1"	3/4"	3/4"/1"
ProMix 2015 1 1/4" Stainless Steel	~8 1/4"	2 3/16"	3 1/8"	2 3/16"	1 7/8"	2 3/4"	3 3/4"	N/A	1 11/16"	3 7/8"	1 1/4"	3/4"	1 1/4"

I. Manifold Assembly

Manifold Length dimension for multiple zones

Manifold zones	2	3	4	5	6	7	8	9	10	11	12	13	14
Length [in]	7 1/4"	9 1/4"	11 1/4"	13 1/4"	15 1/8"	17 1/8"	19 1/8"	21 1/16"	23"	25"	27"	29"	31"

1. Installation

In the manifold cabinet:

The brackets of the heating manifold are secured to the moveable C-rails via the prepared bolts or boreholes. Please follow the respective mounting instructions.

Connection to heating manifolds:

Depending on the model kit, ProMix Manifolds are supplied with either a ball valve set and/or a filling set. The manifold pipes are each fitted with a 1" or 1 1/4" female thread for mounting of the

ball valves / filling set. These original parts can be mounted as self-sealing parts using O-rings or washers. We cannot assume liability or extend any warranty if external parts are used.

Please consult the instructions on pipe mounting when connecting the pipes to the screw connection parts.

To fill the heating manifold, screw hoses with 3/4" hose nozzles to the male thread of the filling cocks. The valves can be opened and closed by turning the side-mounted square

hub to the right/left (using a bleed key).

The heating circuits can be identified by attaching self-adhesive labels to the manifold block. This ensures correct assignment of the outlets of the manifold to the various rooms.

The manifolds are factory-tested for seal-tightness (using the differential pressure method) and proper functioning. The testing pressure for the manifolds is 6 bar / 87 psi. The closing dimension of the valves is 1/2 inch.

II. Tube installation:



Cut off the plastic / copper tube at a right angle and de-burr. Ensure your cut is square to tubing . Push the sleeve nut over the tube.



Push the clamping ring over the pipe and insert the brass PEX-to-manifold connector.

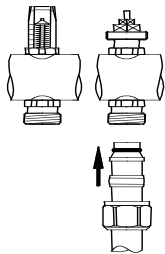

Insert the pre-assembled pipe into the screw connection.

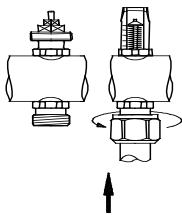

Screw on the clamping ring nut by hand. Push the plastic pipe up to the stop.

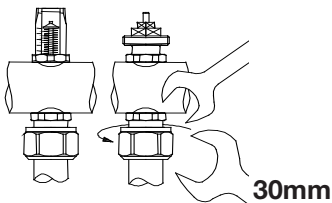

Counter the outlet screw connection using an open-ended wrench and tighten the clamping ring nut using an open-ended 30mm wrench. (Force approx. 25-30 Nm) (Force approx. 18 lbs ft)

III. Setting the flow control:

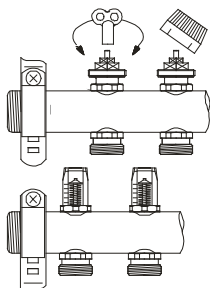

Remove the plastic cap and close the valve by turning to the right using a bleed key (close = smallest volume).

IV. Setting of the flow control:

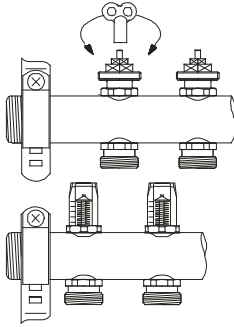

Adjust the required flow volume by turning the regulation spindle to the left.

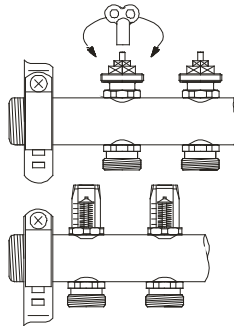

Adjust the flow volume by turning the spindle. The actual flow volume can be viewed on the supply-sided flowmeter.

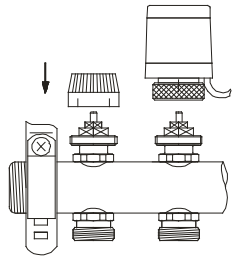

After adjusting the flow volume put the dust cap or the actuator back over the valve spindle to avoid dust contamination or damage to the valve.

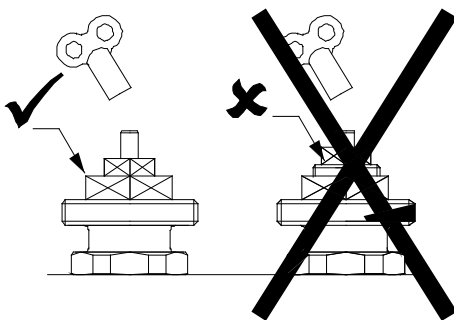

The fine thread of the adjusting spindle must not be seen above the edge of the size 19 hex! Based on closed status, the valve is open (full flow) after 2 1/2 - 3 turns to the left.

Note: If proportional drives are used, the regulating spindle must be opened at least 0.5 to 1 revolution irrespective of the adjusted flow volume. The room temperature is then regulated via the actuator.

V. Adjustment of regulation valves (1» Stainless Steel Manifold)

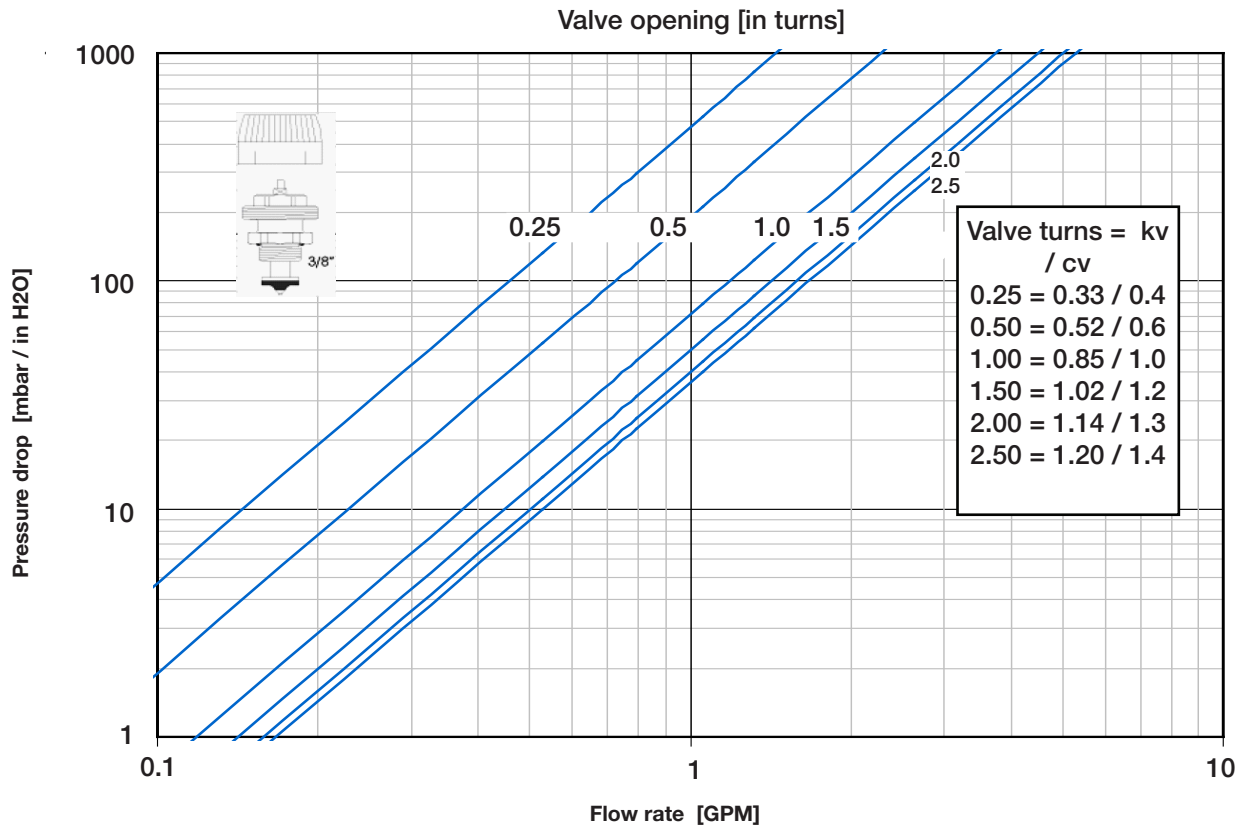

VI. Total pressure drop (ProMix 2013/2015 Stainless Steel Manifold w/ Flowmeter)

